

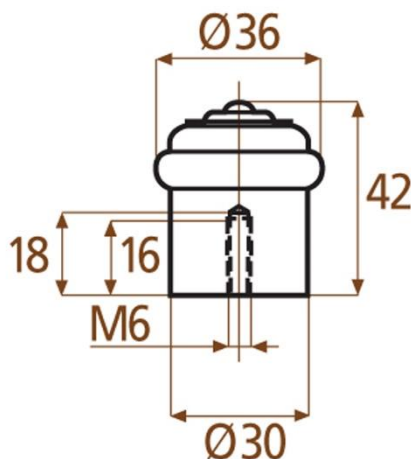











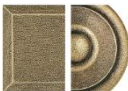

FICHE PRODUIT

BUTÉE DE PORTE FRANCE



Référence	Désignation
1750200	Butée de porte au sol

Disponible en acier et en laiton dans les finitions suivantes :

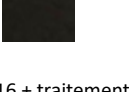
ACIER **		LAITON	
	NR Noir mat RAL 9005		LV Laiton massif Vieilli + vernis brillant
	SN Noir mat RAL 9005 + traitement anti corrosion ***		LVM Laiton massif Vieilli + vernis mat
	SP Shérardisé Patiné – traitement anti corrosion *** + vernis brillant		LP Laiton massif Poli + vernis brillant
	SR Shérardisé Rustique – traitement anti – corrosion*** + vernis mat		LS Laiton massif satiné + vernis brillant
	RO**** Rouillé ciré – rouille naturelle + cire brillante		LBM Laiton massif Brossé + vernis Mat
	RV**** Rouillé Verni – rouille naturelle + vernis mat		NS Nickelé Satiné
	FA**** Fer ancien + vernis mat		NB Nickelé Brillant
			VB Vieux Bronze sur base laiton massif

** Existe également en blanc brillant RAL 9016 (BC) et blanc brillant RAL 9016 + traitement anti corrosion (SW) – autres RAL, nous consulter. *** Les accessoires de fixation peuvent ne pas présenter les mêmes caractéristiques. ****En extérieur ou en milieu humide, les finitions rouillées peuvent continuer d'évoluer.